

HITACHI INVERTER

REMOTE OPERATOR
WOP

INSTRUCTION MANUAL

Thank you for purchase of “Remote Operator”. This manual explains about treatment of “Remote Operator”. By reading this manual and an instruction manual of inverter use practically for installation, maintenance, and inspection. After reading this manual, keep it handy for future reference.

Make sure to reach this manual to the end user.

After reading this manual, keep it handy for future reference.

NT214X

HITACHI

SAFETY

To get best performance with the Remote Operator, carefully read this manual and all of the warning labels attached to the Remote Operator before installing and operating it, and follow the instructions exactly. Keep this manual handy for quick reference.

Definitions and Symbols

A safety instruction (message) includes a "Safety Alert Symbol" and a signal word or phrase such as **WARNING** or **CAUTION**. Each signal word has the following meaning:



HIGH VOLTAGE

This symbol indicates high voltage. It calls your attention to items or operations that could be dangerous to you and other persons operating this equipment.

Read the message and follow the instructions carefully.



WARNING

WARNING

Indicates a potentially hazardous situation that, if not avoided, can result in serious injury or death.



CAUTION

CAUTION

Indicates a potentially hazardous situation that, if not avoided, can result in minor to moderate injury or serious damage to the product. This situation described in the **CAUTION** may, if not avoided, lead to serious results. Important safety measures are described in **CAUTION** (as well as **WARNING**), so be sure to observe them.

NOTE

NOTE

Notes indicate an area or subject of special merit, emphasizing either the product's capabilities or common errors in operation or maintenance.



HAZARDOUS HIGH VOLTAGE

Motor control equipment and electronic controllers are connected to hazardous line voltages. When servicing drives and electronic controllers, there may be exposed components with cases or protrusions at or above line potential. Extreme care should be taken to protect against shock.

Stand on an insulating pad and make it a habit to use only one hand when checking components. Always work with another person in case an emergency occurs. Disconnect power before checking controllers or performing maintenance. Be sure equipment is properly grounded. Wear safety glasses whenever working on electronic controllers or rotating machinery.

SAFETY PRECAUTIONS

WARNING

Never modify the unit.
Otherwise, there is a danger of electric shock and/or injury.

CAUTION

Avoid locations of high temperatures, high humidity, dew condensation, dust, corrosive gases, explosive gases, combustible gases, coolant mist and sea damage etc. Install indoors, to avoid direct sunlight and the unit should be well ventilated.
Otherwise, there is a danger of electric shock and/or injury.

Revision History Table

No.	Revision Contents	The Date of Issue	Instruction Manual No.
1	Initial Release	MAY. 2013	NT214X

TABLE OF CONTENTS

Chapter 1	Introduction.....	1
1.1	Main Features	1
1.2	Unpacking and Inspection	1
1.3	Request upon asking.....	2
1.4	Warranty for the unit.....	2
1.5	About the handling	2
Chapter 2	Name of parts and functions of WOP	3
2.1	Name of parts and contents	3
2.2	Operation keys and their functions	4
2.3	Initialize Inverter	5
2.4	LCD display	6
2.5	Connect to SJ700,L700,X200 and WJ200 (before Version 2.0).....	8
Chapter 3	Connection, wiring, and attaching.....	9
Chapter 4	Operation.....	10
4.1	Changing display mode	10
4.2	Operation of Monitor mode A	12
4.3	Operation of Monitor mode B	13
4.4	Operation of Function mode	14
4.5	Operation of Trip mode.....	15
4.6	Operation of Option mode	16
Chapter 5	Read, Write function and operation	19
5.1	R/W Storage Mode: Single ▪ READ function.....	20
5.2	R/W Storage Mode: Single ▪ WRITE function	21
5.3	R/W Storage Mode: Quad ▪ READ function	22
5.4	R/W Storage Mode: Quad ▪ VERIFY function	24
5.5	R/W Storage Mode: Quad ▪ WRITE function	25
5.6	Operation condition of read and write function	26
Chapter 6	Inverter setting concerning WOP.....	27
Chapter 7	Error message	28
Chapter 8	Trouble shooting.....	30
Chapter 9	Specification	31
9.1	Specification	31
9.2	Dimensions.....	32
9.3	Battery exchange.....	33

1.1 Main Features

This remote operator WOP features state-of-the-art components and functions to provide user-friendly interface. WOP can connect to WJ200 inverter (Ver.2.0 or above) and has 5-line display that shows parameters (function code and name). WOP makes it possible to operate the inverter remotely.

It has an additional function of reading parameter settings and EzSQ program from the inverter to the WOP's memory. Then you can connect the WOP to another inverter and write the parameter settings and EzSQ program into it.

WOP possesses all the functions of SRW-OJ and SRW-OEX as described in Tab. 1.

Tab. 1 Available Connecting Inverters

Inverters	Display	Mounting on Inverter	Remarks	Notes
WJ200 series (Ver.2.0 or above) (NOTE 1)	22 characters ×5 lines	N/A	Multi-Language (NOTE 2)	When using WJ200 with version before Ver.2.0 (no Version printed on the nameplate), set the inverter type to 2. (Refer to section 4.6)
X200 series (NOTE 3)	16 characters ×1 lines	N/A	English Only	When using X200, set the inverter type to 2. (Refer to section 4.6)
SJ700/L700 series (NOTE 3)	16 characters ×2 lines	A	English Only	When using SJ700/L700, set the inverter type to 2. (Refer to section 4.6)
NE-S1 series	22 characters ×5 lines	N/A	English Only	

(NOTE 1) When using WJ200 (before Ver.2.0), only READ/WRITE function is available.

(NOTE 2) Refer to section 4.6 for more details about language setting and its specification.

(NOTE 3) Some functions are restricted such as clock monitor function and so on.

1.2 Unpacking and Inspection

Please don't shake the product when you open the package.

Please take a few moments to unpack your new WOP and perform these steps:

- (1) Look for any damage that may have occurred during shipping.
- (2) Verify the contents of package including the main body of WOP (with built-in battery) and one instruction manual.
- (3) Inspect the nameplate and make sure it matches the product model you ordered.

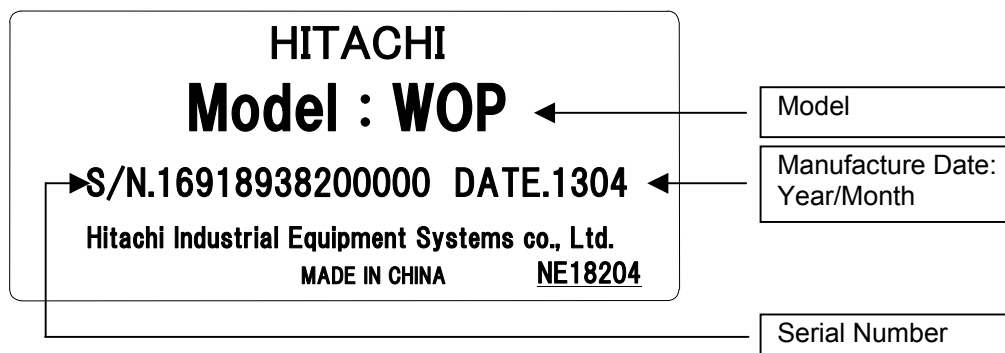

Fig. 1 Nameplate contents

1.3 Request upon asking

To receive technical support for WOP you purchased, please contact the Hitachi inverter dealer from you purchased the operator, the sales office or factory. Please provide the following information:

- (1) Model
- (2) Serial Number (S/N)
- (3) Date of purchase
- (4) Symptoms of any problem

For cutting unoperating time, we recommend that a spare WOP is equipped with.

1.4 Warranty for the unit

The warranty period under normal installation and handling conditions is one year from the purchase date, or two years from the date of manufacture, whichever occurs first. The warranty shall not cover coin type lithium battery built-in. The warranty covers replacement of WOP, at Hitachi's sole discretion.

Service in following cases, even in warranty period, will be charged to the purchased.

- (1) Malfunction or damaged caused by mis-operation or modification or improper repair
- (2) Malfunction or damaged caused by a drop after purchase and transportation
- (3) Malfunction or damaged caused by fire, earthquake, flood, lightning, abnormal input voltage, contamination, or other natural disasters.

The warranty covers WOP only. Any damage caused to third party equipment by malfunction of the remote operator is not covered by the warranty.

1.5 About the handling

The following display must be indicated when products using lithium primary batteries (with more than 6 ppb of perchlorate) are transport to or through the State of California, USA.

**Perchlorate Material - special handling may apply.
See www.dtsc.ca.gov/hazardouswaste/perchlorate**

The WOP has the lithium primary battery (with more than 6 ppb of perchlorate). Label or mark the above display on the exterior of all outer shipping packages of your products when exporting your products which the WOP are installed to the State of California, USA.

2.1 Name of parts and contents

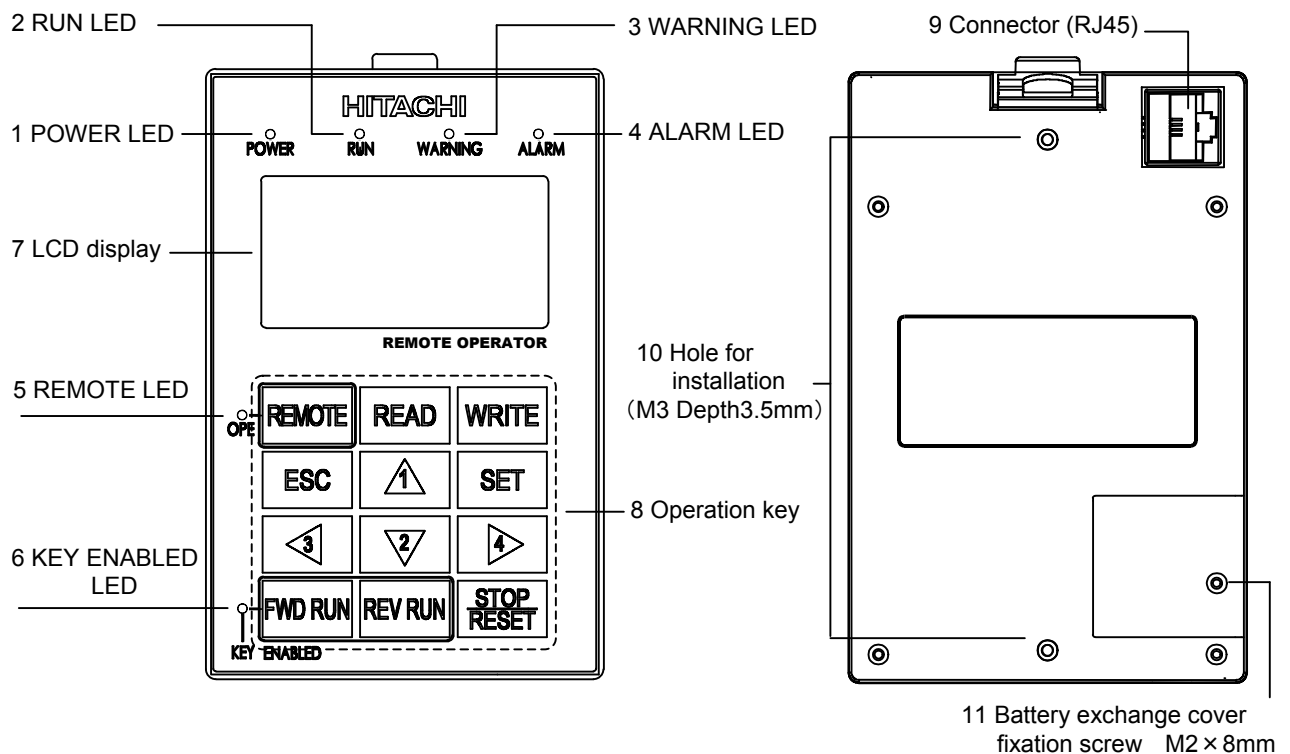

Tab. 2 Name of parts and contents

No.	Name of parts	Color	Contents
1	POWER LED	Green	Light on when power is supplied to the operator.
2	RUN LED	Green	Light on when the Inverter is running.
3	WARNING LED	Red	Light on when parameter setting is incorrect.
4	ALARM LED	Red	Light on when the Inverter trips.
5	OPE LED	Green	Light on when the REMOTE key makes the compulsion operation function effective. It doesn't light when the compulsion operation function is effective by input terminal OPE. (Press the key more than 2s)
6	KEY ENABLED LED	Green	Light on only when operation command is set in operator.
7	LCD display		Refer to section 2.4 for details.
8	Operation key		Refer to Tab. 3 for details.
9	Connector		It can be connected to the main body of the Inverter via a cable (optional).
10	Hole for installation		It is the hole for installation on the control panel. Please fix with M3 screw.
11	Battery exchange cover fixation screw		Please unscrew this one and detach the cover for replacing the battery. (NOTE1) (Refer to section 9.3 for more details)

(NOTE1) Because the first battery is for operation check, it may become the life immediately.

2.2 Operation keys and their functions

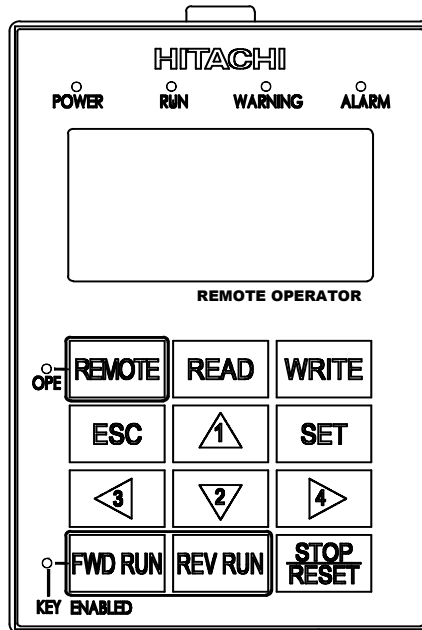

In the case of connecting to WJ200 (Ver.2.0 or above) or NE-S1, key functions are shown in Tab. 3.

Display mode transitions are described in section 4.1.

Tab. 3 Name and function of operation key

No.	Key Name	Function
1	REMOTE	Remote key can change operation command and frequency command method to the operator. Press the key more than 2 seconds, can change to the operator, and quit from operator after press the key more than 2 seconds again.
2	READ	The key is used to transfer inverter parameters to the WOP's memory. (Refer to chapter 5 for more details.)
3	WRITE	The key is used to copy the parameter settings in WOP to inverter. (Refer to chapter 5 for more details.)
4	ESC	<ul style="list-style-type: none"> ·Back to above layer. ·Cancel the change of parameter.
5	SET	<ul style="list-style-type: none"> ·Go ahead to below layer. ·When at edit layer, the change of set will be stored and back to above layer via pressing the key.
6	△ (1)	<ul style="list-style-type: none"> ·Cursor will move up, or function code will plus“1”. ·Value will plus “1” when press the key.
7	▽ (2)	<ul style="list-style-type: none"> ·Cursor will move down, or function code will minus“1”. ·Value will minus “1” when press the key.

No.	Key Name	Function
8	◀ (3)	·The key is used to move left. ·It moves to the previous mode when the display is navigation layer.
9	▶ (4)	·The key is used to move right. ·It changes display mode from one to another when the display is navigation layer.
10	FWD RUN	Motor runs forward. The key is used for operating motor only when operation command (A002) is set in operator or the compulsion operation function is effective. (Check KEY ENABLED LED, whether it is flashing or not.)
11	REV RUN	Motor runs reverse. The key is used for operating motor only when operation command (A002) is set in operator or the compulsion operation function is effective. (Check KEY ENABLED LED, whether it is flashing or not.)
12	STOP/RESET	The key is used to stop the motor, or reset an alarm. It is also possible to invalidate the STOP key when setting parameter. The key does not response when WOP reads or writes the parameters from or to inverter.

2.3 Initialize Inverter

According to the following procedure to initialize inverter via WOP.

Inverters	Initializing procedure
WJ200 series (Ver.2.0 or above)	Set parameter "b180" (Please refer to inverter instruction manual)
X200 series	(1) set parameter b084/b085. (Please refer to inverter instruction manual) (2) Press [ESC] and [▽] key, then press [△] key. (3) Release [△] key at first then release [ESC] and [▽] keys
SJ700/L700 series	(1) set parameter b084/b085. (Please refer to inverter instruction manual) (2) Press [ESC] and [◀] key, then press [▽] key. (3) Release [▽] key at first then release [ESC] and [◀] keys
NE-S1 series	Set parameter "b180" (Please refer to inverter Quick Reference Guide)

2.4 LCD display

In the case of connecting to WJ200 (Ver.2.00 or above) or NE-S1, the status and color of LCD backlight and the details of LCD display are described as follow.

Backlight

When connecting to WJ200 (Ver.2.0 or above) or NE-S1, there are two kinds of backlight colors of LCD display, white and orange, and the state of the inverter is displayed by different colors as described in Tab. 4.

Tab. 4 Backlight colors of LCD display

Backlight Color	Contents
White	Normal (It is not related to inverter's driving/stop)
Orange	Warning (Parameter mismatch)
White ⇄ Orange (Alternate blinking for one second)	Trip (The same as ALARM LED)

The details of LCD display

When connecting to WJ200 (Ver.2.0 or above) or NE-S1, the first line of LCD monitor always displays the display mode, the number of the control object, the state of the inverter, and the display selection. (Refer to Fig. 2 and Tab. 5)

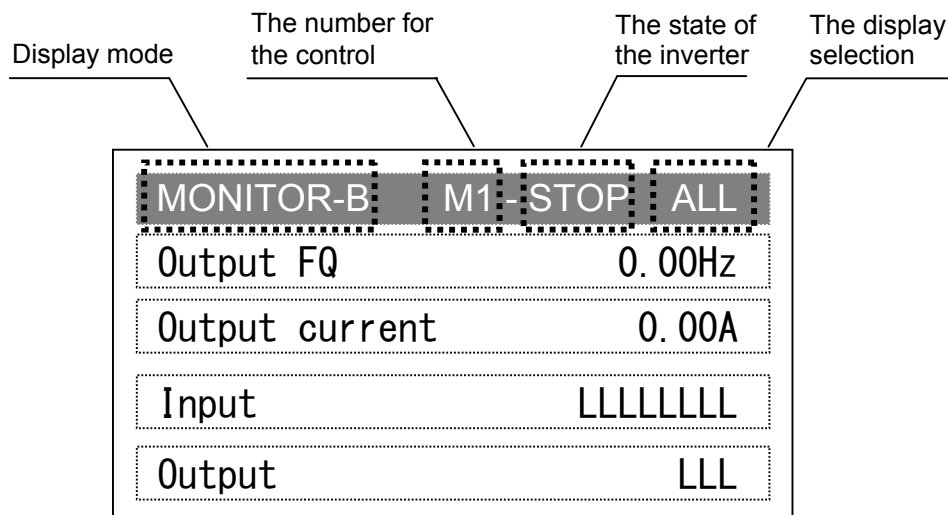

Fig. 2 LCD display

Tab. 5 The first line of LCD display

Item	Display character	Contents
Display mode	MONITOR-A	Monitor mode A
	MONITOR-B	Monitor mode B
	FUNCTION	Function mode
	TRIP	Trip mode
	WARNING	Warning mode (Alarm)
	OPTION	Option mode
The number for control (NOTE1)	M1	The first control object
	M2	The second control object.
The state of inverter	STOP	Stopped
	FWD	Forward running
	REV	Reverse running
The display selection (b037)	ALL	Display all
	UTL	Each function display
	USR	User setting display
	CMP	Data compare display
	BAS	Basic display
	MON	Monitor display only

(NOTE1) The number for the control object is a motor number when two or more motors are switched and controlled. (Refer to Inverter instruction manual for more details)

2.5 Connect to SJ700,L700,X200 and WJ200 (before Version 2.0)

Display contents and operation system of WOP are different according to the inverter type that is connected to. When WOP is connected to SJ700, L700, X200 and WJ200 (before Version 2.0), it displays in the same way of former remote operators such as SRW-OJ and SRW-OEX. Otherwise, the differences of LED and functions of key are described in Tab. 6.

Tab. 6 Differences between former inverter

KEY & LED of WOP	WJ200 (Ver.2.0 or above), NE-S1	L700, SJ700, X200
REMOTE (Long push)	Compulsion operation function effective / invalid	
REMOTE (Short push)	(No response because of absence of the function)	Move to monitor mode (Monitor/MON key)
READ	Reading of parameter	Reading of parameter (Read/READ key)
WRITE	Writing of parameter	Writing of parameter (Copy/COPY key)
ESC	Back to the upper layer	Move to function mode (Function/FUN key)
SET	Store the setting value / Enter the lower layer	Store the setting value (Store/STR key)
POWER LED	Power on	
RUN LED	Inverter is running	
WARNING LED	Warning happened	(LED always turns off because of absence of the function)
ALARM LED	Inverter trip happened	
OPE LED	The compulsion operation function is effective by the operator	
KEY ENABLED LED	Operation command key is effective	

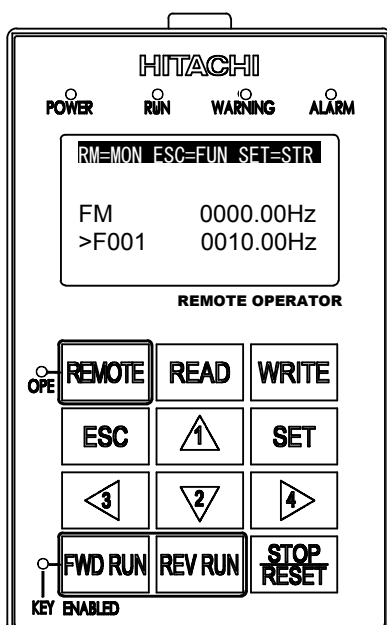

WOP

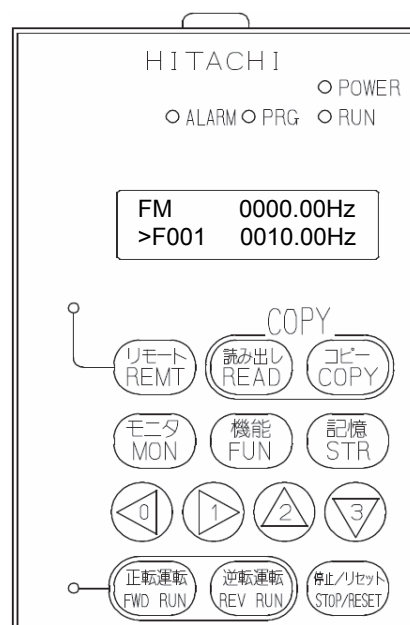

SRW-OJ (the same as SRW-OEX)

Fig. 3 Comparison of WOP and SRW-OJ/SRW-OEX

Before install the operator on the control panel, please fix with M3 screws from the back of the control panel. (2 holes, the same measurement as figure 4, has to be made at first)

When connecting to the inverter, please use cable which is recommended. Otherwise, please use the cable with appointed dimension.

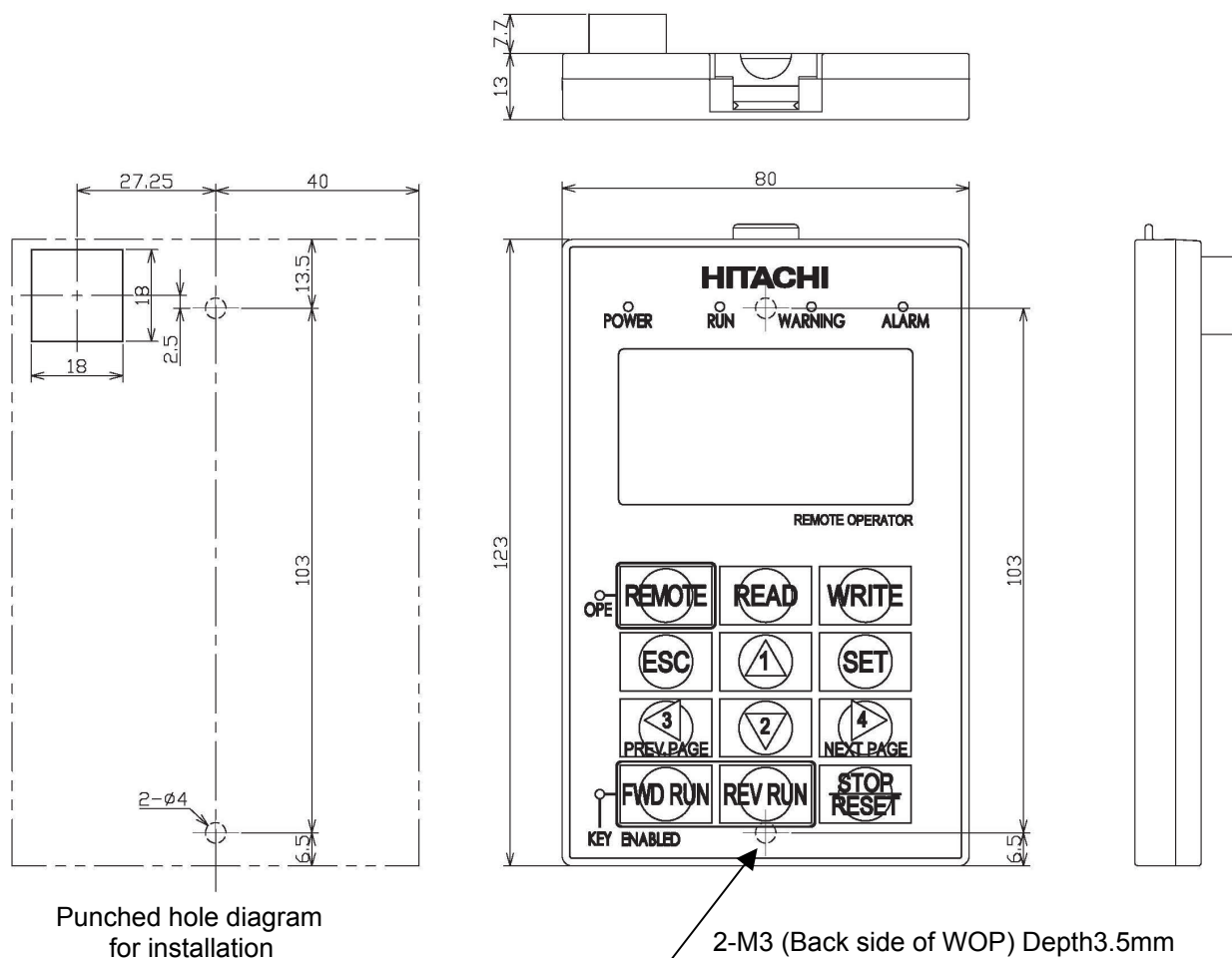

Fig. 4 Diagram for punched holes' dimensions

Tab. 7 Recommended cable

Model	Content
ICS-1	1m cable
ICS-3	3m cable

Make sure to use a straight cable within 3m in length and 10BASE-T category 5 (CAT5) of UTP or STP when the cable is prepared by the customer.

(NOTE) UTP (Unshielded twist pair cable) , STP (Shielded twist pair cable) .

4.1 Changing display mode

When connecting to WJ200 (Ver.2.0 or above) or NE-S1, WOP has four display modes which can be changed from one to another via pressing the [◀] or [▶] key at Navigation level. Moreover, there are 3 other modes: Read mode, Write mode and Option mode. In any display mode, it moves to Read mode or Write mode via pressing [READ] key or [WRITE] key and moves to Option mode after pressing [◀], [△] and [▽] at the same time. It returns to display modes via pressing [ESC] key.

Each mode has its own layers, display contents and parameter settings cannot be changed at Navigation layer while they can be changed at Edit layer. (Please see figure below.)

When pressing [SET] key at Navigation layer, a cursor will appear and screen will move to below layer.

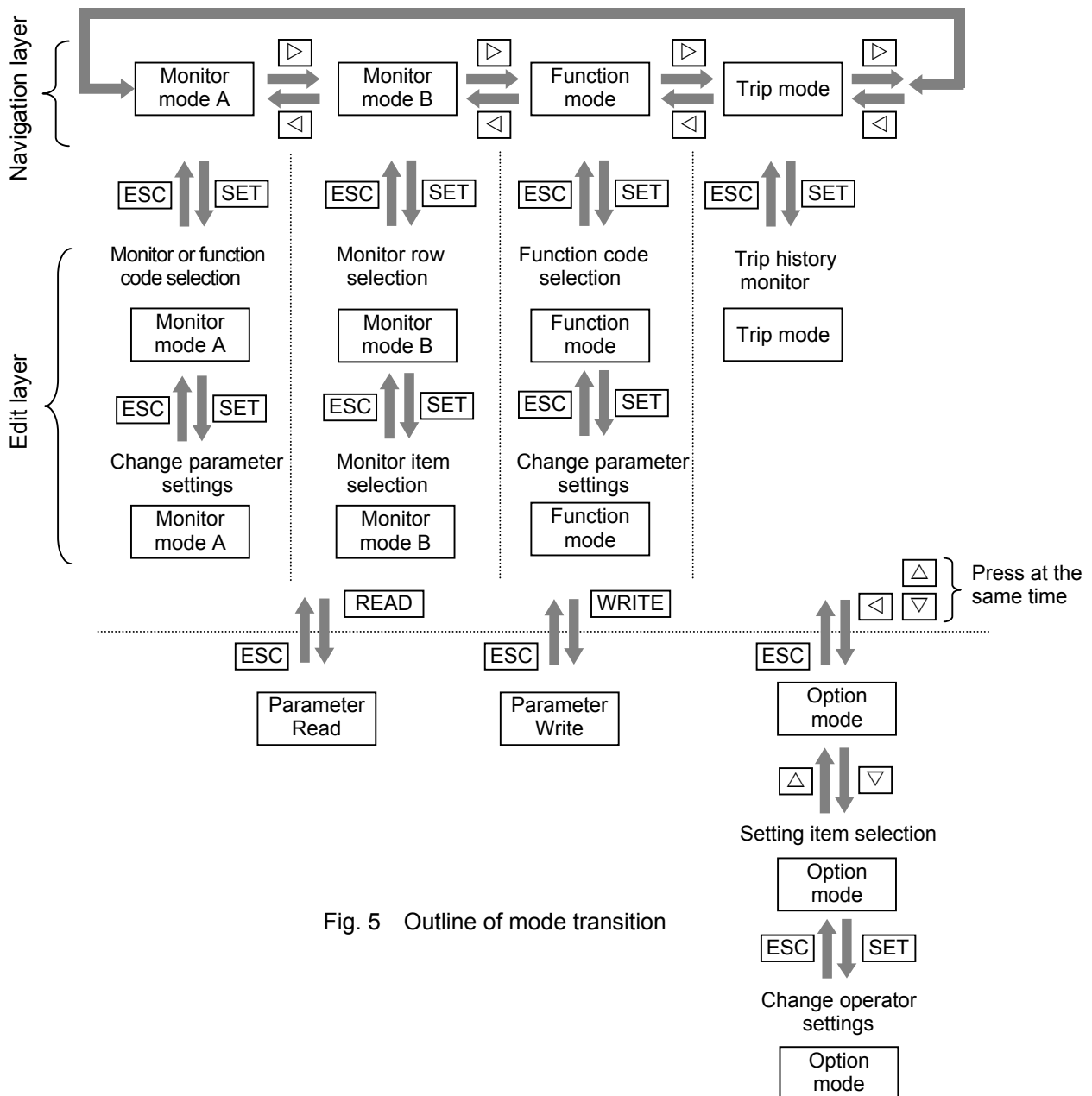

Fig. 5 Outline of mode transition

The outline of each mode is shown as follows.

The chosen of parameter b038 decides the power-on display of inverter when connecting to WJ200 (Ver.2.0 or above) or NE-S1.

Monitor mode A (Monitor + Setting)

On the same screen in this mode, the “d” group inverter parameters can be displayed , moreover, “F”, “A”, “b”, “C”, “H”, “P”, “U”group inverter parameter can be setted. The content of “d” group parameter is displayed with big font. The function code such as “F001” and contents of “F”, “A”, “b”, “C”, “H”, “P”, “U” parameters are displayed, while function names of these parameters are not displayed. Please use function mode if you want the function name to be displayed.

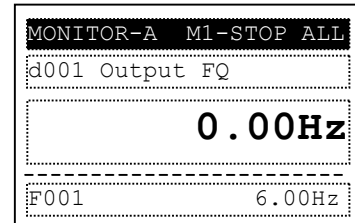

Monitor mode B (Monitor × 4)

In this mode, four “d” group inverter parameters can be displayed at the same screen while function codes of these parameters are not displayed.

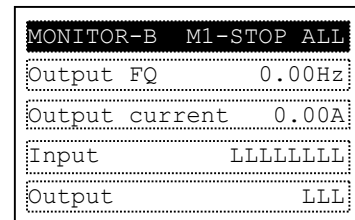

Function mode (Setting)

In this mode, “F”, “A”, “b”, “C”, “H”, “P”, “U” group parameters can be displayed and setted. Function code, function name, parameter content and parameter range are displayed.

(NOTE) “d” group inverter parameter cannot be setted and displayed in this mode.

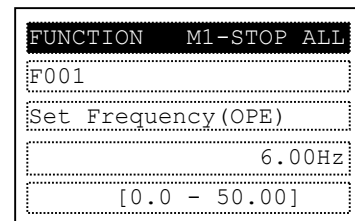

Trip mode

Trip information and warning information are displayed in this mode. When inverter trip or warning happens, the present screen will switch to the trip mode screen automatically.

At navigation layer, the trip reason will be displayed in big font.

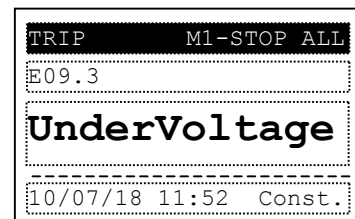

Option mode

In this mode, you can set [Language], [Date and Time], [INV Type Select] and so on.

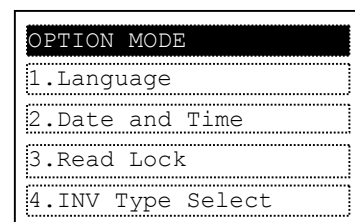

4.2 Operation of Monitor mode A

1. Please select monitor mode A via pressing the [◀] or [▶] key at navigation layer. The cursor will not appear at this layer until pressing the [SET] key.

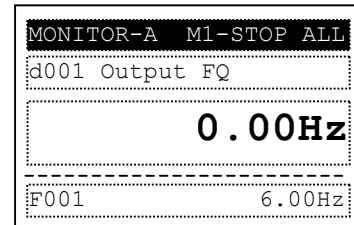

2. After pressing the [SET] key at navigation layer, it moves to edit layer and the cursor appears at the monitor code part.

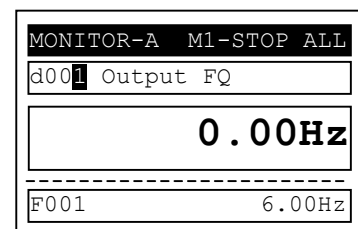

[change of Monitor item of “d” group]

Pressing the [△] or [▽] key to select the function code to display monitor item that you want.

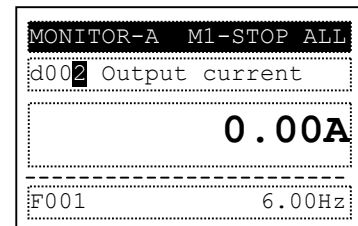

[change of function item of “F”, “A”, “b”, “C”, “H”, “P”, “U” group]

Pressing the [◀] or [▶] key to move the cursor to the code part of function item (F001 as right figure), then pressing the [△] or [▽] key to change the function code.

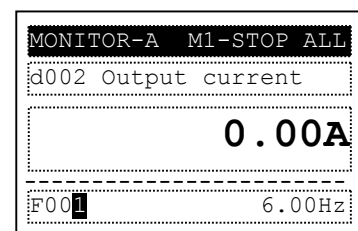

3. It entries into the below layer after pressing the [SET] key and the cursor appears on the parameter part of a function item. Pressing the [△] or [▽] key to change data. It returns to the upper layer after storing parameter via pressing the [SET] key. And the change is cancelled and returns to the upper layer via pressing the [ESC] key.

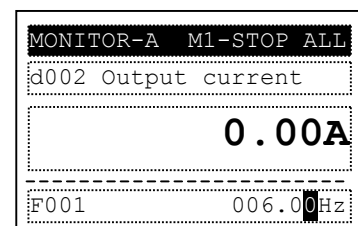

4.3 Operation of Monitor mode B

1. Please select monitor mode B via pressing the [◀] or [▶] key at navigation layer. The cursor will not appear at this layer until pressing the [SET] key.

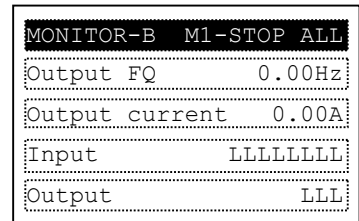

2. After pressing the [SET] key at navigation layer, it moves to edit layer and the cursor appears at the first row of the monitor item. Use the [△] or [▽] key to select the row of monitor item.

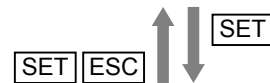
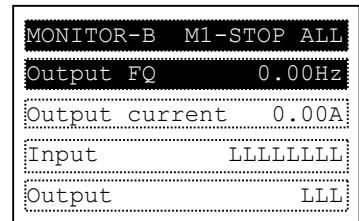

3. It enters into the below layer after pressing the [SET] key and the cursor appears at the function code of the item. Pressing the [△] or [▽] key to select the code. After pressing the [SET] key, the monitor item is selected, and it returns to the upper layer. After pressing [ESC] key, the change is cancelled and returns to the previous display.

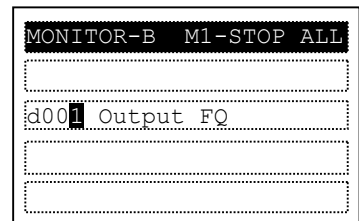

4.4 Operation of Function mode

1. Please select function mode via pressing the [◀] or [▶] key at navigation level. The cursor will not appear at this layer.

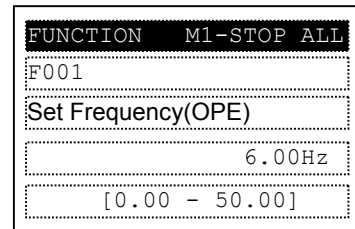

2. Press the [SET] key to move to edit layer and the cursor appears in the character of function group, And pressing the [△] or [▽] key to select the group that you want.

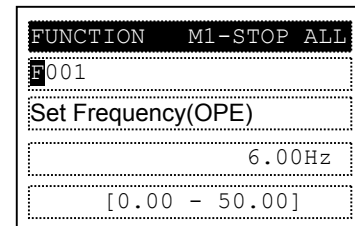

[change of function item of “F”, “A”, “b”, “C”, “H”, “P”, “U” group]

Pressing the [◀] or [▶] key to move the cursor to the code part of function item (F001 as right diagram), then pressing the [△] or [▽] key to change the function code.

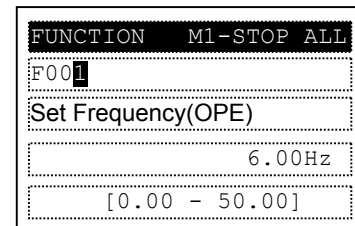

3. It entries into the below layer after pressing the [SET] key. Pressing the [△] or [▽] key to select the data which you want to set. It returns to the upper layer after storing parameter via pressing the [SET] key. Pressing the [ESC] key will cancel the change and returns to the upper layer.

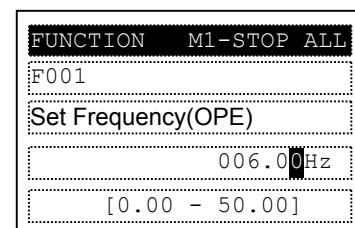

4.5 Operation of Trip mode

1. Pressing the [◀] or [▶] key to select trip mode at navigation layer.
2. Pressing the [SET] key entries into the below layer. This mode will display the past trip information (6 times) and warning information (1 time). Each trip information includes two pages.

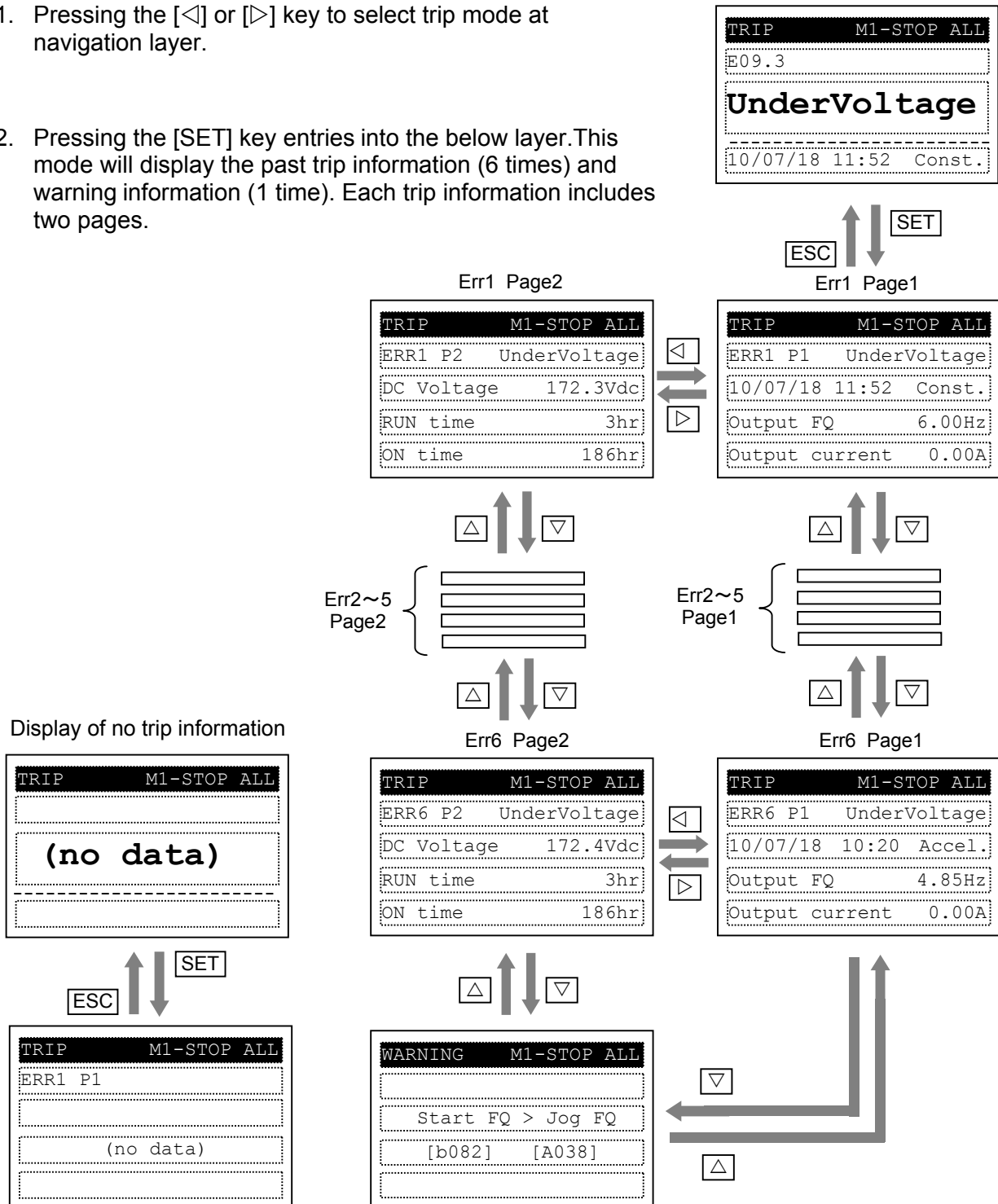

(NOTE1) When trip happens, ALARM LED will be illuminated and the inverter can be reset via pressing the [STOP/RESET] key.

(Parameter b087 decide the function of the [STOP/RESET] key)

(NOTE2) Because of different inverter states, trip time may be not saved and displayed.

(NOTE3) When trip happens, the backlight state becomes flicker whatever the state of [Backlight Auto-off] is. (Refer to section 4.6)

4.6 Operation of Option mode

1. Please press the [◀], [△] and [▽] key at the same time to enter into the OPTION MODE. The cursor will appear in the first row. Pressing the [△] or [▽] key to select the item. Pressing the [ESC] key it will return to previous display.

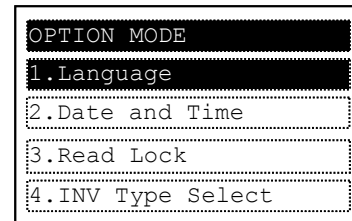

2. Pressing the [SET] key enters into the below layer and edit the item directly. After set the required data via pressing the [△] or [▽] key, pressing the [SET] key to store the parameter and return to the upper layer. Pressing the [ESC] key will cancel the change and returns to the upper layer.

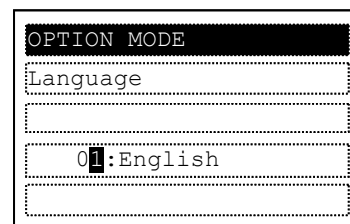

Tab. 8 The contents of Option mode

No.	Item	Content	Setting range	Default
1	Language	Setting language. If the language is not installed, it is displayed in English. (NOTE1)	01: English 02: Deutsch (German) 03: Français (French) 04: Español (Spanish) 05: Italiano (Italian) 06: Português (Portuguese) 07: 日本語 (Japanese) 08: 中文 (Chinese) 09: Türkçe (Turkish) 10: Русский (Russian) (NOTE 1)	English
2	Date and Time	Setting date and time. Day of the week is changed automatically with the date. (NOTE2)	format : 1 date: 2009/01/01~2099/12/31 time: 00:00 ~ 23:59 format : 2 date: 01/01/2009~12/31/2099 time: 00:00 ~ 23:59 format : 3 date: 01/01/2009~31/12/2099 time: 00:00 ~ 23:59	2009/01/01 00:00 format 1
3	Read Lock	Protect the parameter in WOP that has been saved from being overwritten. If the state of Read Lock is [01:Enable], READ operation is impossible. (NOTE3)	01: Enable 02: Disable	Disable
4	INV Type Select	Selecting the correct inverter type. "COM ERROR" will be displayed if the incorrect inverter type was selected.	01: Type 1 (WJ200: Ver.2.0 or above, NE-S1) (NOTE4) 02: Type 2 (L700, SJ700, X200)	Type 1
5	R/W Storage Mode	Reflecting the quantity of setting of parameter sets that can be stored in WOP. (Refer to chapter 5 for more details.)	01: Single 02: Quad	02
6	Backlight Auto-Off	LCD backlight will be turned off automatically if there was no operation within 1 minute. The Backlight Auto-Off function does not work when trip happens.	01: Off 02: 1 minute	Off
7	Backlight Flicker	Setting the flicker state (Yes/No) of orange backlight. If [02:Disable] is selected, the orange backlight won't flicker in the case of trip status.	01: Enable 02: Disable	Enable

No.	Item	Content	Setting range	Default
8	Operator Reset	Resetting all the settings of WOP to the default. After reset operation, date and time setting is required.	01: YES 02: NO	NO
9	Check Mode	Checking whether LED and key etc. are normal or not.	1.Key & Led Check 2.Lcd Check 3.RTC Check 4.EEPROM Check(NOTE5) 5.Serial Loopback (NOTE6) 6.Debug Mode 7.Firmware Version	-

(NOTE1) When WOP (firmware version 1.00) connecting to WJ200 (Ver.2.0 or above), English , Japanese and Chinese are available, while connecting to L700, SJ700, X200 and WJ200 (version before 2.0) or NE-S1, only English is available.

(NOTE 2) In the case of connecting to WJ200 (Ver.2.0 or above) or NE-S1, Clock display function (d031) is provided as following diagram.

MONITOR-A M1-STOP ALL	
d031 Clock	
07/18	12:28

F001	6.00Hz

(NOTE 3) When [Read Lock] is set to [01: Enable], READ operation is unavailable (display as follows). Pressing [ESC] key will return to the previous display.

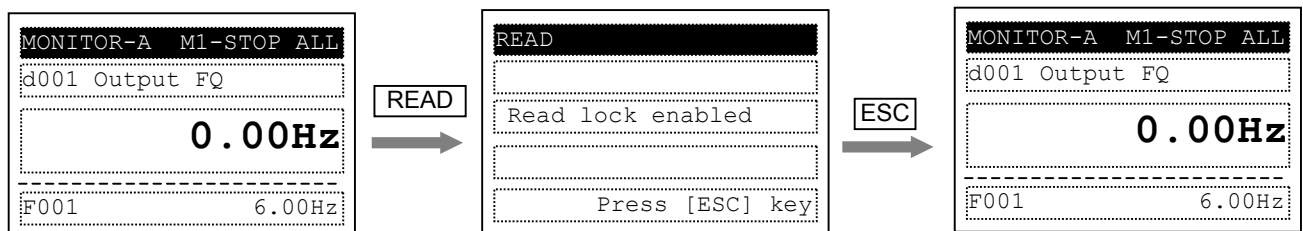

(NOTE4) When connecting to WJ200 (Ver.2.0 or above), please set [INV Type Select] to [01: Type 1]. [read & copy only] will display if [02: Type 2] is selected.

(NOTE5) Please do not execute the [EEPROM Check]. Otherwise, the data (parameters/EzSQ program) saved in WOP will be erased.

(NOTE6) Please do not execute the [Serial Loopback]. Communication check is not allowed without proper tools.

Chapter 5 Read, Write function and operation

WOP can read and save Inverter parameter, and copy them to another inverter.

WOP can save four inverters' parameter or one inverter's parameter and its EzSQ program. It can be selected via changing item of R/W Storage Mode in Option mode. (Refer to section 4.6)

Date of Read/Write operating and inverter type are saved in WOP. Standard inverter type code which is mentioned in inverter catalog is listed in following table.

Inverters	NE-S1	WJ200 (Ver. 2.0)	WJ200 (before Ver.2.0)	SJ700-2	SJ700-1	L700	X200
Type code	INV89	INV81	INV78	INV71	INV64	INV80	INV65

For example, "1.100718 14:50 INV81" displayed on screen means that the parameter of WJ200 Ver.2.0 (INV81) were saved in the first block of wop's memory at 14:50 on July 18,2010.

Usually, parameter can not be copied between different type Inverters.

If Read operation and parameter verify (EzSQ verify) cannot be executed, please verify whether the [Read Lock] in option mode is "02: Disable". Besides, there are some possible restrictions caused by the parameter in Inverter. Refer to section 5.6 for more details.

5.1 R/W Storage Mode: Single · READ function

When the R/W Storage Mode is selected to [01: Single], the parameter Read or Write is executed immediately after pressing [READ] or [WRITE] key. It is convenient to write the parameters into numerous inverters (the same type) continuously.

After pressing the [READ] key in any display mode (except Write mode and Option mode), the parameter settings of the inverter are read and saved into WOP. EzSQ program read is transferred to WOP automatically after parameter reading is finished. If the inverter supports EzSQ function, it returns to previous display after read is completed.

Please note that the data saved in WOP will be overwritten.

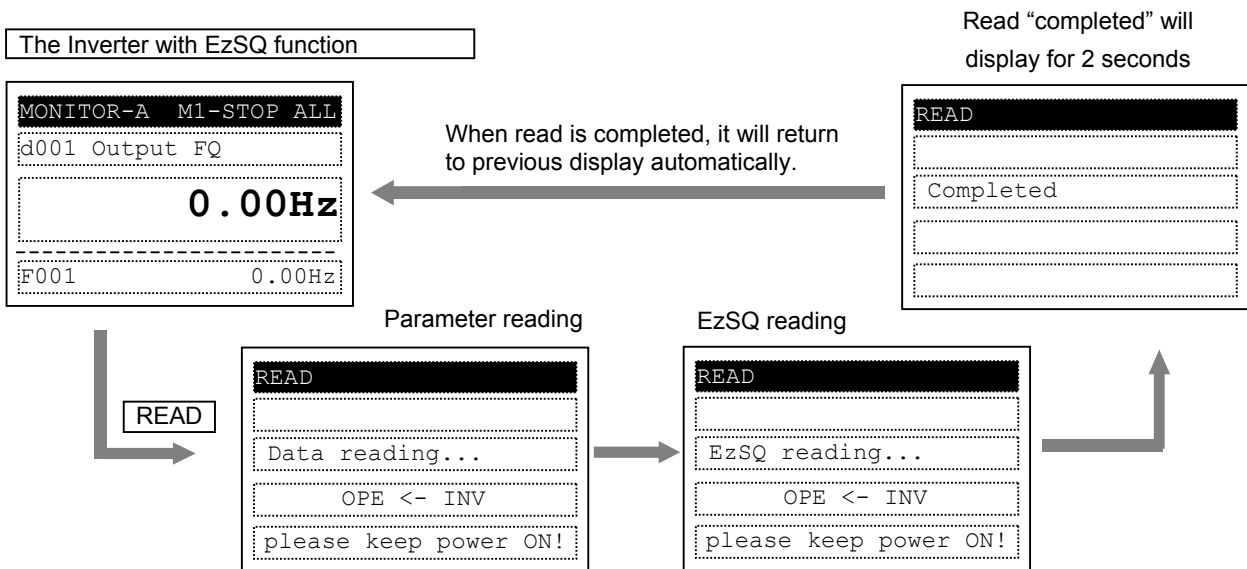
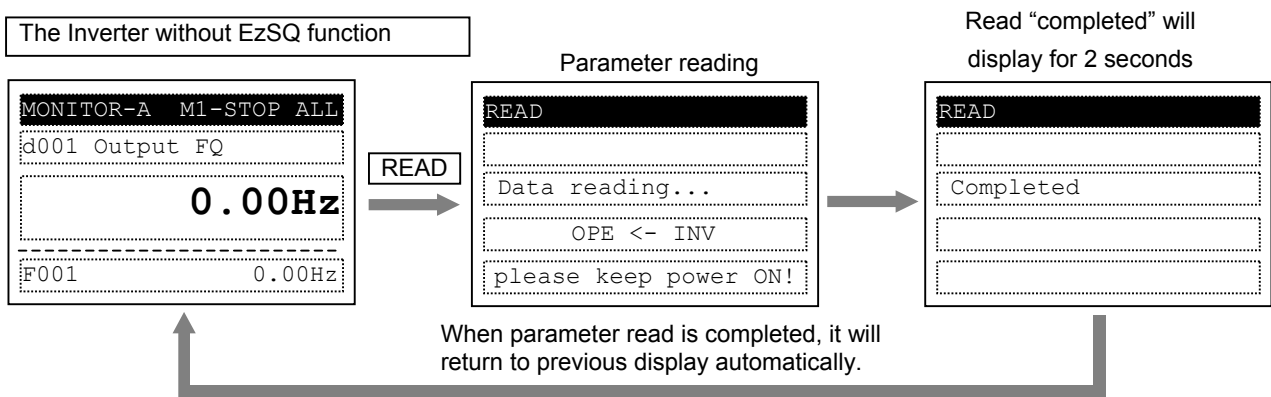

(NOTE) All inverter parameters saved in WOP are overwritten after pressing the [READ] key.

5.2 R/W Storage Mode: Single · WRITE function

After pressing the [WRITE] key in any display mode except Read mode and Option mode, the parameter settings stored in WOP are transferred to the inverter. EzSQ program is transferred to the inverter automatically after parameter copy is finished if the Inverter supports EzSQ function. It returns to previous display after write is completed.

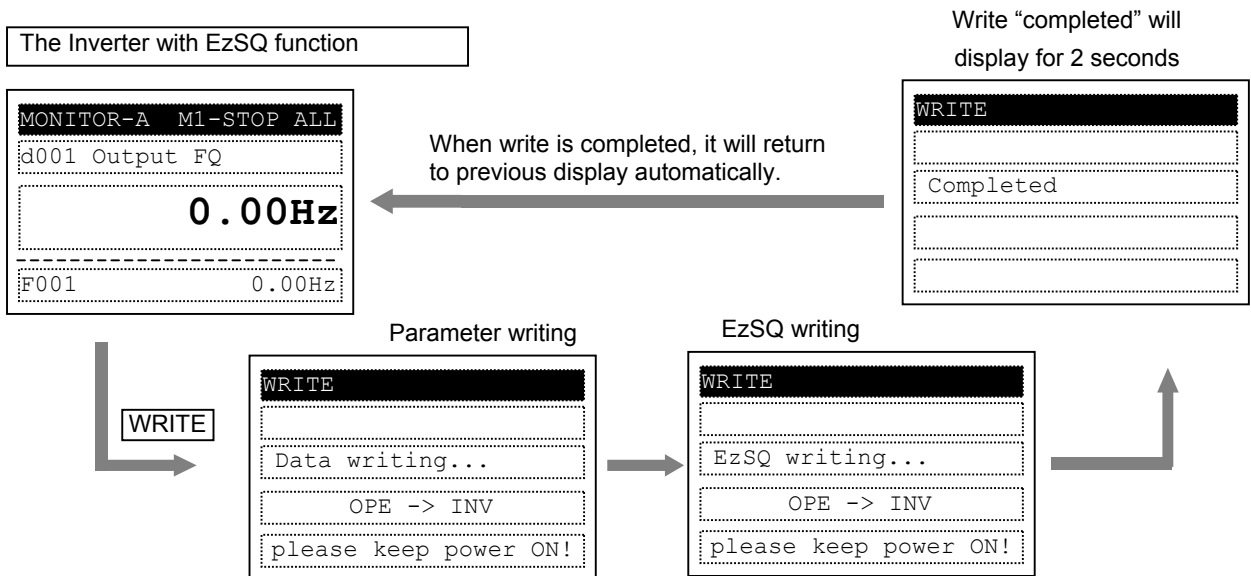
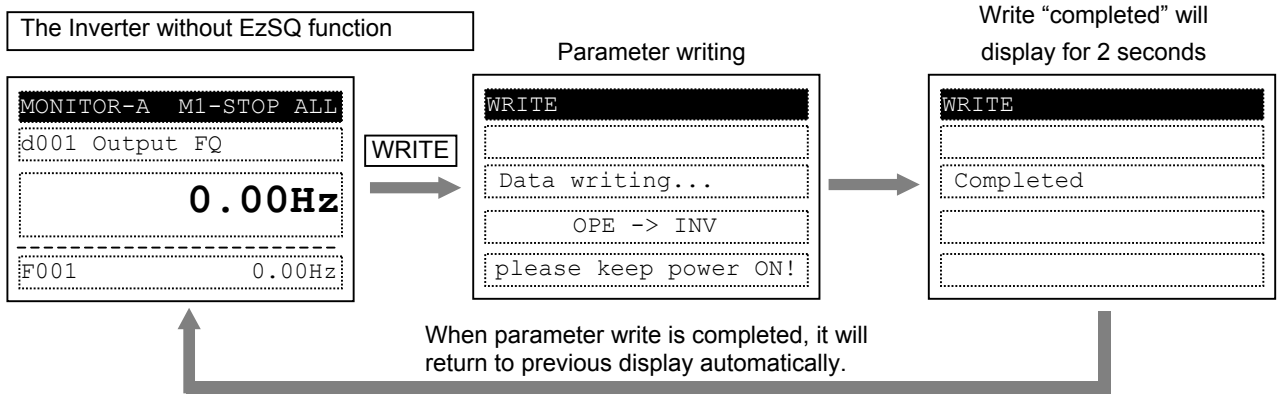

5.3 R/W Storage Mode: Quad · READ function

It is possible to handle four sets of inverter parameters or read/write EzSQ program independently when the item of [R/W storage mode] is selected to [02: Quad]. In this case, WOP can save four sets of inverter parameters or one set of inverter parameters and one EzSQ program. Please note that one EzSQ program takes up memory area of three sets of inverter parameters, which are No.2, No.3 and No.4.

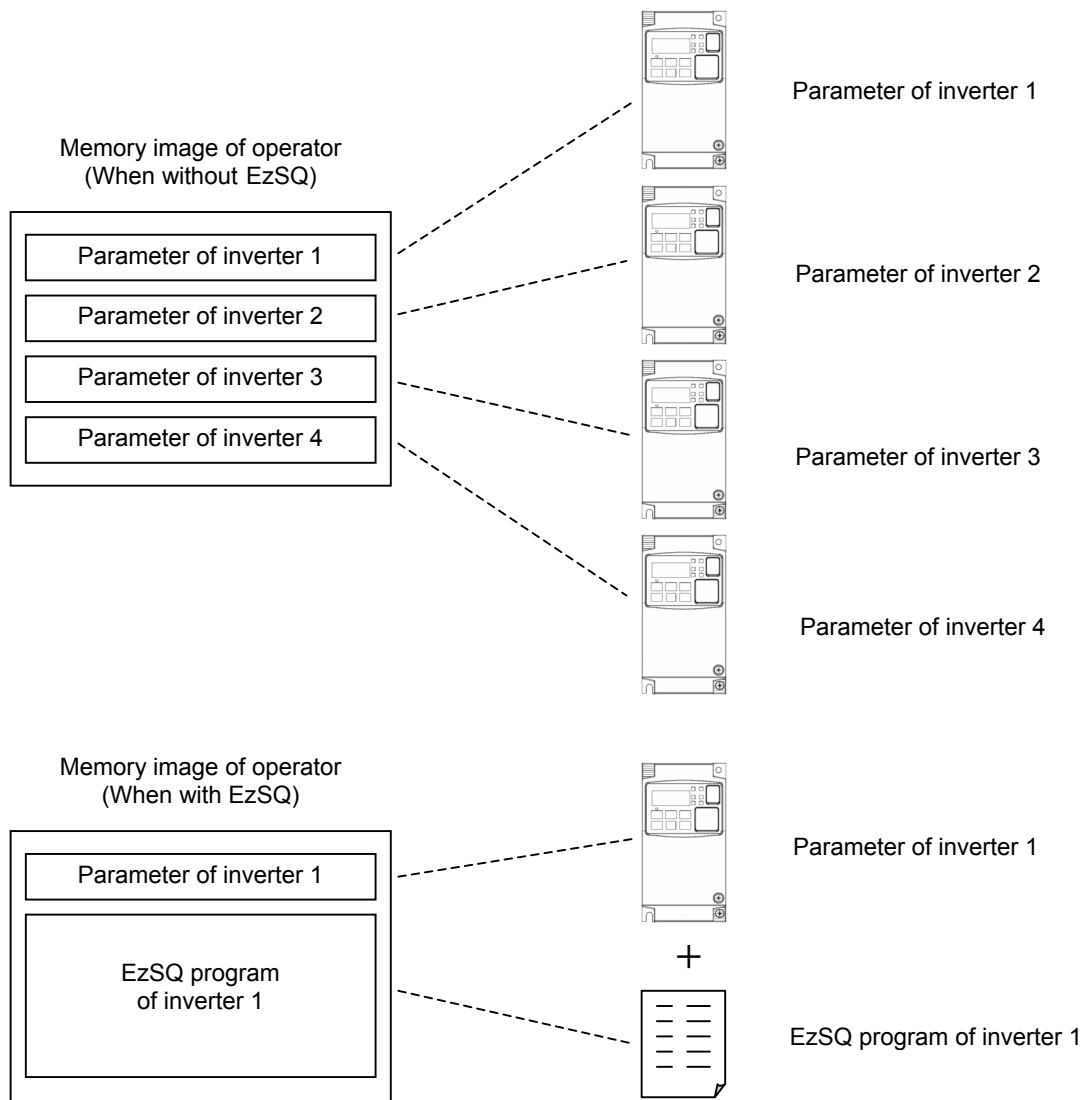

In any display mode except Write mode and Option mode, the read screen is displayed after pressing the [READ] key. If there are no parameters stored in operator, it shows "--", as described in the right figure.

Use the [△] or [▽] key to move the cursor up and down to select the memory number to be stored.

After pressing the [SET] key, 5 selection items are displayed as described follows.

- 01: Read data
- 02: Read data+EzSQ
- 03: Verify data
- 04: Verify EzSQ
- 05: Cancel

NOTE: only three selection items 01, 03 and 05 are displayed when memory No.2, No.3 or No.4 is selected.

A overwritten confirming screen are displayed after the [SET] key is pressed. If approving, press the [SET] key, if not, press the [ESC] key.

This will be displayed when item "02" is selected.

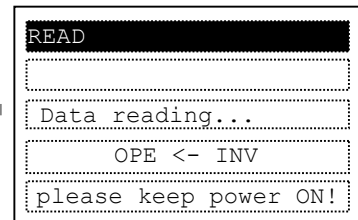
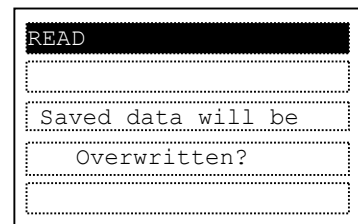
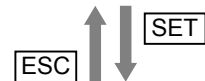
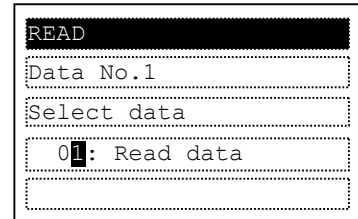
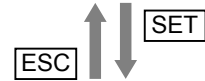
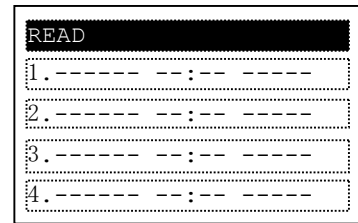
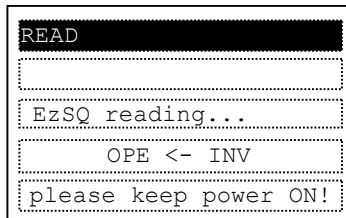

Transform automatically

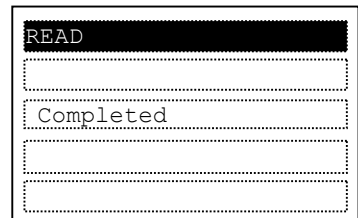

Transform automatically

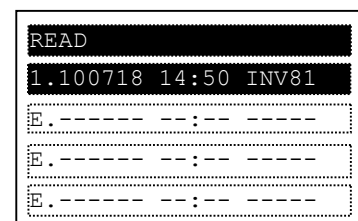

It returns to the navigation layer of read mode automatically after the read is completed, the read operation date and time, inverter type will be updated. (If EzSQ program is saved in WOP, the No.2, No.3 & No.4 will display "E" as described in the right figure.)

5.4 R/W Storage Mode: Quad · VERIFY function

In any display mode except Write mode and Option mode, the read screen is displayed after pressing the [READ] key.

Use the [△] or [▽] key to move the cursor up and down to select the data number to be verified.

When memory number No.1 is selected, it moves to the below layer after pressing the [SET] key. There are five selections described as below, where item 03 and item 04 are selected to verify data and EzSQ.

- 01:Read data
- 02:Read data+EzSQ
- 03:Verify data
- 04:Verify EzSQ
- 05:Cancel

It will displayed when select "04" and the EzSQ be verified.

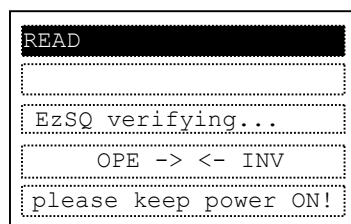

↓ Transform automatically

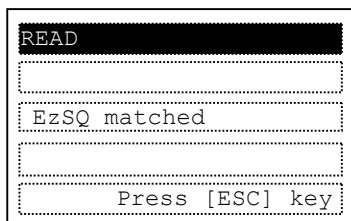

The result is shown automatically after the parameter or EzSQ verification is completed.

It returns to navigation level of Read mode after the [ESC] is pressed.

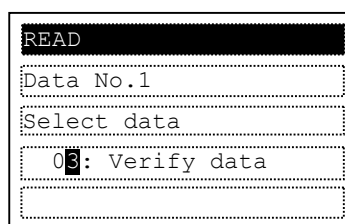
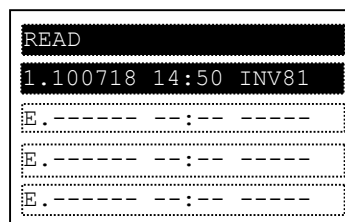

when select [03: Verify data]

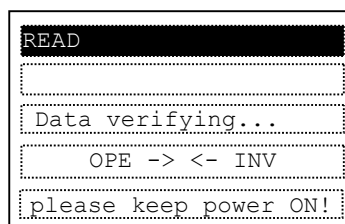

↓ Transform automatically

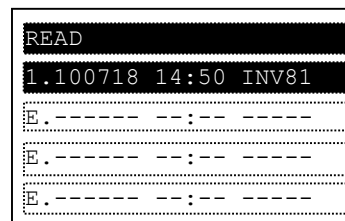
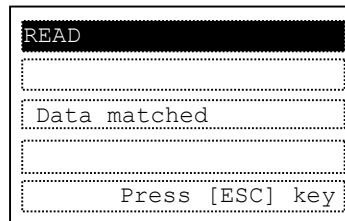

5.5 R/W Storage Mode: Quad · WRITE function

In any display mode except READ mode and Option mode, the write screen is displayed after pressing the [WRITE] key .

Use the [△] or [▽] key to move the cursor up and down to select the data number to be written.

After pressing the [SET] key, 3 selection items is displayed as described follows.

- 01: Write data
- 02: Write data+EzSQ
- 03: Cancel

Note: only two items 01 and 03 are displayed when memory No.2, No.3 or No.4 is selected.

It will be displayed when item "02" is selected.

The parameters are written after the [SET] key is pressed. The display of data is shown as described in the right figure.

After the parameter writing is completed, it returns to navigation level of the write mode automatically.

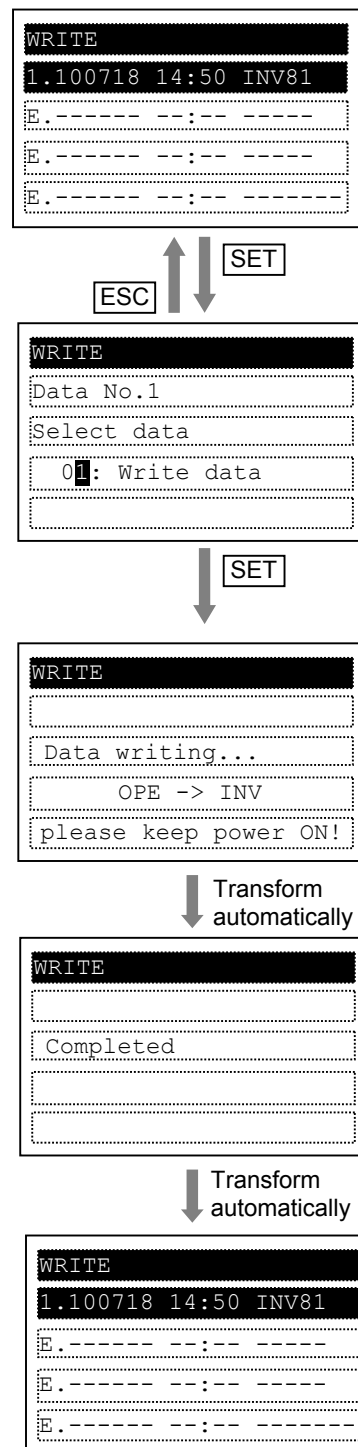

5.6 Operation condition of read and write function

Please note that the read and write function are invalidated according to the state and the setting of inverter as shown in below table.

The operation condition of reading or verifying parameter (WOP←INV)

State and setting of inverter	Only parameter	Parameter+EzSQ
Inverter is running, EzSQ is running, written unable.	Valid	Valid
Soft locked (b031)	Valid	Valid
Display is limited (b037)	Valid	Valid
Trip happened	Valid	Valid

The operation condition of writing parameter (WOP→INV)

State and setting of inverter	Only parameter	Parameter+EzSQ
Inverter is running, EzSQ is running, written unable.	Invalid	Invalid
Soft locked (b031)	Invalid	Invalid
Display is limited (b037)	Valid	Valid
Trip happened	Invalid	Invalid

In trip status: WRITE unavailable

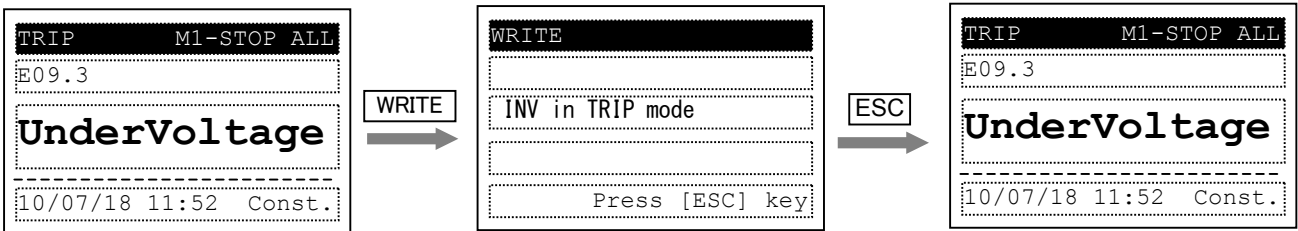

In running status: WRITE unavailable

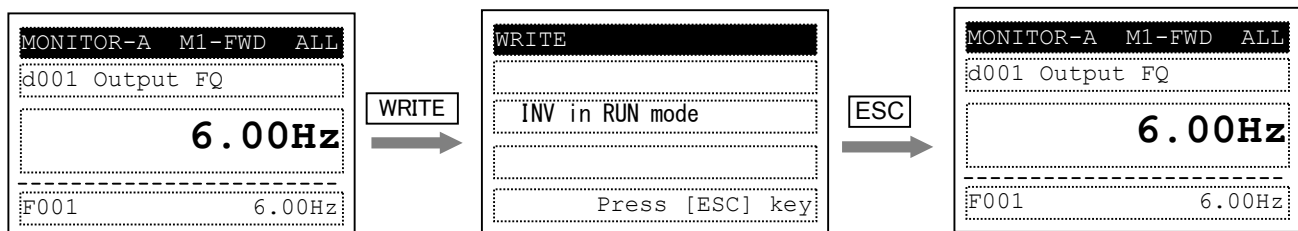

(NOTE) When [R/W Storage Mode] is set to [01: Single]. (Refer to section 4.6)

Chapter 6 Inverter setting concerning WOP

The example below explains parameter settings of WJ200 (Ver.2.0 or above) concerning WOP.

Tab.9 The parameter of inverter related to WOP

No.	Code	Function name	Content	Setting parameter
1	F001	Output frequency setting	You could set the frequency when the frequency instruction is done from the operator.	Start FQ~ Max. FQ
2	A001	Frequency source	Select the frequency instruction source.	00: VR 01: Terminal 02: Operator 03: Modbus 04: Option 06: Pulse 07: EzSQ 10: Math
3	A002	Run command source	Select the run/stop command source.	01: Terminal 02: Operator 03: Modbus 04: Option
4	b031	Software lock mode selection	It is a function to prevent the change in data.	00: Lock(SFT) 01: Only FQ(SFT) 02: Lock 03: Only FQ 10: RUN chg mode
5	b037	Function code display restriction	Select the mode of the parameter displayed in the operator.	00: All 01: Utilize 02: User 03: Compare 04: Basic 05: Monitor
6	b038	Initial display selection	Select the start display.	000: The last display after the [SET] key be pressed. 001~060: Display set by d001~d060 201: Display of F001 202: Monitor mode B of WOP
7	b081	Data R/W selection	Restrict the data read/write by operator.	00: Data read/write enable 01: Data read enable / write disable 02: Data read disable / write enable 03: Data read/write disable
8	b087	Stop key selection	Make the STOP key of operator enable/disable.	00: Enable 01: Disable 02: Enable when reset a trip
9	b164	Automatic return to the initial display	It will change into the display which set by initial display selection (b038) automatically when no operation to the operator within ten minutes.	00: Enable 01: Disable
10	C001 ~ C007	Intelligent Input terminal function	If it sets to 31(OPE) and the input is turned on, the frequency instruction and the run command source will set to operator compulsorily.	31: Set to operator compulsorily
			If it sets to 51(F-TM) and the input is turned on, the frequency instruction and the run command source will set to terminal compulsorily.	51: Set to terminal compulsorily
			It shows the display which set by initial display selection (b038) when it sets to 86(DISP) and the input is turned on.	86: Display limitation

Error messages displayed on the screen are classified into errors related to inverter and WOP errors. They appear on the screen as shown below.

(For inverter error messages, please refer to the inverter instruction manual)

(1) The message related to inverter

Display	Cause	Check item	Resetting Method
COM ERROR	No signal is received from the inverter within 4 sec.	<ul style="list-style-type: none"> • Check Inverter type • Check the connector for looseness/disconnection. 	<ul style="list-style-type: none"> • Change to correct Inverter type. (Refer to section 4.6) • Replace the cable. (Please use the recommended cable)
INV in TRIP mode	WRITE key is pressed while the inverter trips.	Check if the inverter trips.	Reset the inverter from the trip status.
INV in RUN mode	<ul style="list-style-type: none"> • The WRITE key is pressed while the inverter is running. • Soft-lock is turned ON. 	<ul style="list-style-type: none"> • Check if the WRITE key is pressed while the inverter is running. • Check if the WRITE key is pressed while Soft-Lock is ON. 	<ul style="list-style-type: none"> • The WRITE key should be pressed only while the inverter stops. • Release the Soft-Lock (of the inverter).
INV Type Un-match	An attempt was made to write parameter between different type inverters.	Check inverter type	Writing is possible only between the same type inverters.
Read lock enabled	Read operation is unavailable	Check [Read Lock] is enable or disable	Release [Read Lock]
INV Check Sum Error	The parameters in WOP and the parameters written into the inverter are unmatched.	Check write operation is available or not when inverter is power-on again.	If the same error recurs, please check the inverter (NOTE: It happens sometimes when writing data into a different voltage class and capacity of the inverter.)

(2) WOP error message

Display	Cause	Check item	Resetting Method
EEPROM is broken!	WOP's EEPROM comes to its usage life.	Check read operation is available or not when inverter is power-on again.	If the copy function is needed, please replace the remote operator.
RTC ERROR!	Inductive noise enters into WOP.	WOP (cable) is nearby the inductive noise or not.	Please put WOP and its cable far away from the inductive noise. Please set the right date in option mode.
change the battery	Battery power is exhausted.	Whether right date displays in parameter d031. (Refer to Fig. 7)	Please replace it with new battery.
please set the clock	<ul style="list-style-type: none"> ▪ wop is used at the first time. ▪ wop is used at the first time after battery replaced. ▪ WOP is used at the first time after resetting 	Whether the time setting is match to the correct time.	Please set the right date in option mode.

In this section, the trouble shooting of WOP is described. For the trouble shooting of the inverter, refer to the inverter instruction manual.

(1) No data appears on the screen.

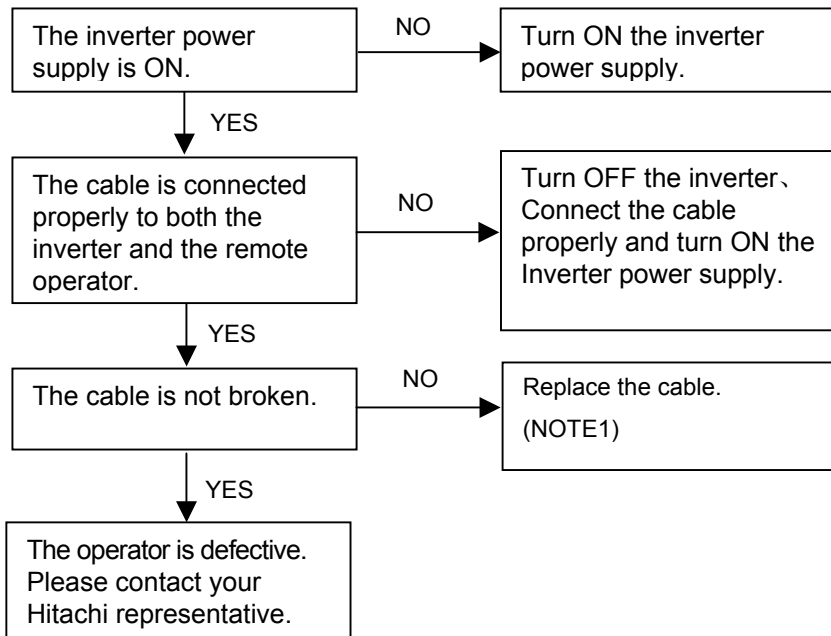

(NOTE) The screen maybe display in uncorrected way with the cable that prepared by yourself. Please use the recommended cable in chapter 3.

- (2) In Option Mode, Read mode or Write mode, [REMOTE] key, [READ] key, [WRITE] key, [FWD RUN] key and [REV RUN] run key are invalid.
- (3) If the operator screen becomes dark or characters cannot be identified, inductive noise may be entered from the cable. Separate WOP cable more than 15 cm from power line cables. To reset the disturbed screen, turn ON any keys of WOP. If the same symptom appears again, turn OFF the inverter power supply or reset the terminal reset signal.
- (4) In case of changing to connect to WOP from other operators such as OPE-S while inverter power is on, it is possible that wop can not display correctly. You can restore power to inverter to correct it.

9.1 Specification

Tab. 10 WOP's standard specification

Specification	Contents
Model	WOP
Display	Liquid Crystal Display (132×64 dots)
Language display	Multi- language for WJ200 (Ver.2.0 or above). (NOTE 1) English for L700, SJ700, X200, NE-S1 and WJ200 (version before 2.0)
External dimension	123(H) × 80(W) × 21 (D) mm
Weight	0.1kg
Ambient temperature	-10 to 50 °C
Humidity	20 to 90% RH (no dew condensation)
Store temperature	-20 to 65 °C
Place to use	1000m or less in height (at a place without corrosion gas and dust).
Seat color	Black
Others	Built-in real time clock (NOTE 2) Backup time (Including power OFF status time): About 2 years@25 °C Built-in battery: Coin type lithium battery CR1220

(NOTE 1) For more information, refer to section 4.6.

(NOTE 2) Because of the influence of the environmental temperature etc., time error maybe occurred.(roughly, time error of wop is about 3 second per day.)

9.2 Dimensions

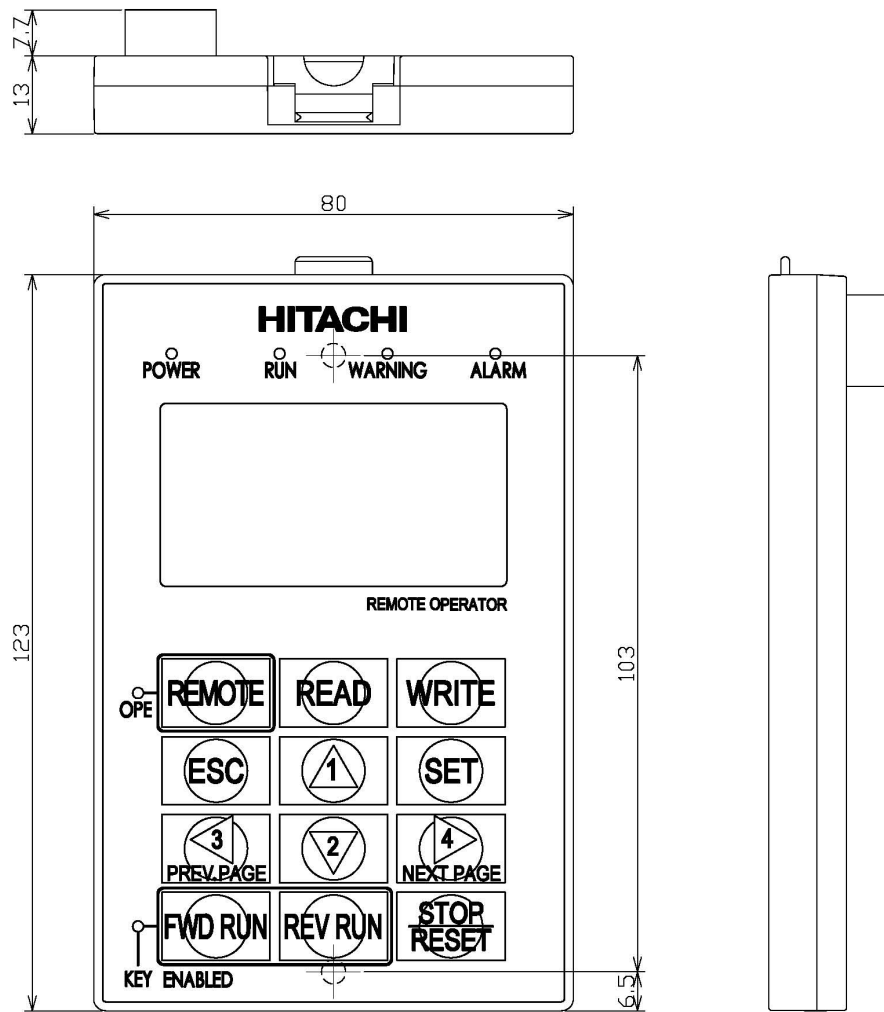

Fig. 6 Dimension of WOP

9.3 Battery exchange

There is a real time clock IC built-in whose power is supplied by a battery when outside power supply is turned off. When the battery comes to its life, the clock IC won't renew the time when power supply of WOP is turned off.

The clock date stored in the IC will be reset to a default value January 1, 2009 when power supply of WOP is turned on. Thus, the time of Trip mode, Read mode and Write mode cannot be displayed correctly unless setting the correct time in Option mode after power supply of WOP is turned on. However, there is no influence for operating except displaying correct time.

When replacing the battery, please take off the battery cover by removing one screw of the operator backside. Please take out the old battery with a thin minus driver, and be careful not to damage PCB and any part on the PCB. The positive (+) pole of the battery (flat one) must be installed upward, the negative (-) pole face to substrate. And inserting the battery, press the battery to reach the edge of the metal case. In addition, please do not touch it because the pin adjacent to a battery is only for an examination of factory shipment. (Refer to Fig. 7)

Please dispose used battery according to local related laws and regulations.

